



17962.0399.1 9906

User instructions

BIASI U.K Ltd
Unit 32/33, Planetary Road
Industrial Estate, Neachelles Lane
Willenhall, Wolverhampton WV13 3XB



TABLE OF CONTENTS

| | | | | | |
|----------|-------------------------------------|----------|----------|----------------------|----------|
| 1 | General | 1 | 2.6 | Extinguishing | 5 |
| 1.1 | Overview | 1 | 3 | Useful advice | 6 |
| 1.2 | Interception valves | 1 | 3.1 | Warnings | 6 |
| 1.3 | Control panel | 1 | 3.2 | Central heating | 6 |
| 1.4 | Technical data | 2 | 3.3 | Built in time switch | 6 |
| 2 | Instructions for use | 3 | 3.4 | Fume control device | 6 |
| 2.1 | Warnings | 3 | 3.5 | Frost protection | 6 |
| 2.2 | Refilling procedure | 3 | 3.6 | Periodic maintenance | 6 |
| 2.3 | Ignition | 3 | 3.7 | External cleaning | 7 |
| 2.4 | Central heating circuit temperature | 4 | 3.8 | Operational faults | 7 |
| 2.5 | Domestic hot water temperature | 4 | | | |

Central heating + domestic hot water models
(combined):
24S, 28S

Central heating only models:
24SR

Remarks

This appliance complies with the EEC directive 90/396 and, therefore, the use of the  mark is allowed.

It also complies with the EEC directive 87/308 relative to the prevention and elimination of radio interference.

This appliance is made in accordance with current European standards regarding the safety of gas appliances and safety in using electrical household appliances.

The manufacturer, in his continuous search to improve his products, reserves the right to modify the data given herein without prior notice.

This documentation is for information purposes only and is not to be considered a contract.

Useful advice

temperature rise in the circuit can cause the pressure relief valve to open.

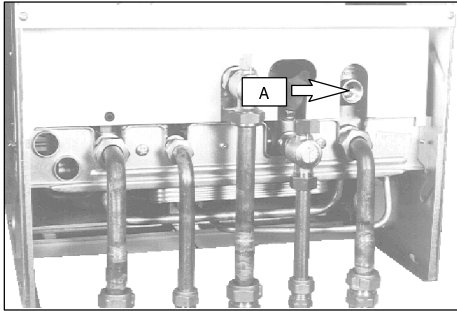

fig. 3.3

So that this does not happen and to decrease the pressure to a normal value, it is advisable to vent some of the water in the appliance through the bleed valves present in the radiators.

If in time, a reduction in domestic hot water supply is observed...

The likely causes may be impurities caught in the domestic hot water flow switch filter or limescale deposited in the domestic hot water heat exchanger. It is advisable to have the appliance cleaned out by an Authorised Service Centre Engineer.

If water should occasionally leak from the boiler...

shut off the taps positioned under the boiler (fig. 2.10 in page 5) and call an Authorised Service Centre Engineer.

In case of problems other than those mentioned here, switch off the boiler, as described in section 2.6 on page 5 and call a competent and responsible service engineer.

1 GENERAL

1.1 Overview

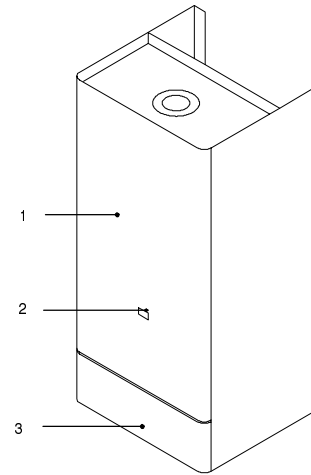

fig. 1.1

- 1 Case front panel
- 2 Burner window
- 3 Lower front panel

1.2 Interception valves

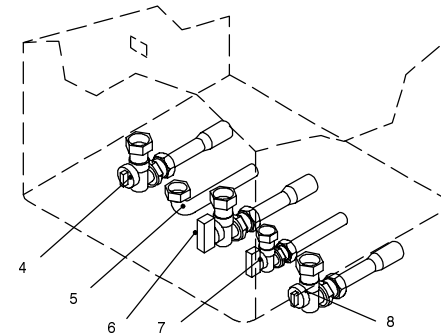

fig. 1.2

- 4 Central heating flow cock
- 5 Domestic hot water outlet pipe
- 6 Gas inlet cock
- 7 Domestic cold water inlet cock
- 8 Central heating return cock

1.3 Control panel

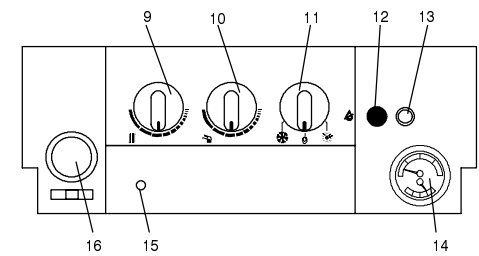

fig. 1.3 mod. 24S, 28S

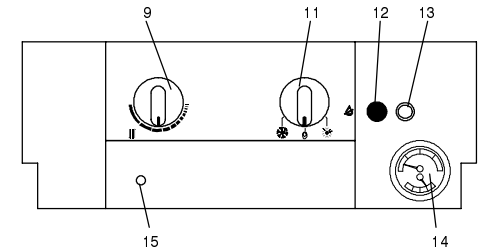

fig. 1.4 mod. 24SR

- 9 Central heating temperature adjustment knob
- 10 Domestic hot water temperature adjustment knob
- 11 Function switch
- 12 Lock-out signal lamp and boiler reset button
- 13 Safety thermostat reset button
- 14 Central heating circuit temperature and pressure gauge
- 15 "Appliance ON" Led
- 16 Time switch (central heating control)*

* To operate correctly the time switch read the separate instructions sheet enclosed with the technical documentation.

General

1.4 Technical data **

| Central heating | | |
|---------------------|-----|-----|
| Maximum temperature | °C | 90 |
| Minimum temperature | °C | 35 |
| Maximum pressure | bar | 3 |
| Minimum pressure | bar | 0,3 |

tab. 1.1

| Domestic hot water (combi boilers only) | | |
|---|-------|------|
| Maximum temperature | °C | 55 |
| Minimum temperature | °C | 37 |
| Maximum pressure | bar | 10 |
| Minimum pressure | bar | 0,3 |
| Max flow rate mod. 24 ($\Delta T = 25 K$) | l/min | 13,7 |
| Max. flow rate mod. 28 ($\Delta T = 25 K$) | l/min | 16 |
| Min. flow rate | l/min | 2,5 |

tab. 1.2

Useful advice

During the service, the most important components of the boiler will be inspected and cleaned. This service can be part of a maintenance contract.

In particular, you are advised to have the following checks carried out:

- primary heat exchanger;
- domestic hot water heat exchanger;
- main burner;
- exhaust fume duct and flue;
- pressurisation of the expansion tank;
- filling up of the central heating circuit;
- bleeding of air from the central heating system;
- general check of the appliance's operation.

3.7 External cleaning

Before doing out any cleaning, disconnect the appliance from the electrical mains, using the fused spur isolation switch fitted with the appliance.

To clean the external panels, use a cloth soaked in soapy water. Do not use solvents, abrasive powders or sponges.

Do not carry out cleaning of the appliance and/or its parts with readily flammable substances (for example petrol, alcohols, naphtha, etc.).

3.8 Operational faults

If the lock-out signal lamp comes on (12 in fig. 3.2)...

this indicates that the safety lock-out has stopped the boiler.

To re-start the boiler, it is necessary to press the boiler reset button (12 in fig. 3.2).

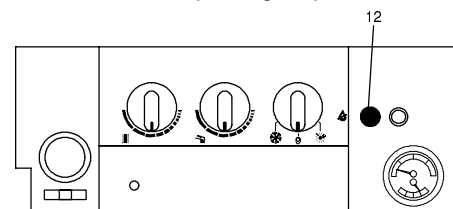

fig. 3.2

For the first lighting up and following maintenance procedures for the gas supply, it may be neces-

ary to repeat the resetting operation several times so as to remove the air present in the pipework.

If the boiler doesn't operate but the lock-out signal lamp remains off...

the safety thermostat may have lock-out in (13 in fig. 3.2) This is reset by pressing the button after taking off the protective cap.

The safety lock-out may also come on after the fume control device, described in section 3.4 of this chapter, cuts in. This is reset by pressing button 12 in fig. 3.2 after taking off the protective cap.

Lock-outs caused by these circumstances should be reported to an Authorised Service Centre immediately.

If the boiler does not light up...

especially after a long period without using the appliance, it is likely that the pump is jammed.

In such a case, turn off the boiler, as described in section 2.5 in page 5 of this manual. Have the pump freed by a competent person as shown in the manual *installation instructions* chapter *preparation for service*.

If noises due to air bubbles are heard during operation...

you should check that the pressure on the temperature and pressure gauge (fig. 2.2 on page 3) is not outside the correct range.

If required, top up the system correctly, as described in the manual *installation instructions* chapter *commissioning*.

Bleed any air present in the radiators, if necessary.

If the pressure on the temperature and pressure gauge (14 on page 1) has gone down...

it is necessary to top up the appliance with water again, so as to raise the pressure to an adequate level. (see fig. 2.2 on page 3).

If topping up with water has to be very frequent, have the system checked for leaks.

If water comes out of the pressure relief valve (A in fig. 3.3)...

Check on the temperature and pressure gauge (14 on page 1) that the pressure in the central heating circuit is not close to 3 bars. In this case,

** For more technical information read the manual *Instructions for the installer*, chapter *General*.

3 USEFUL ADVICE

3.1 Warnings

On detecting the smell of gas:

- don't operate any electrical switches, the telephone or any device that may produce sparks;
- open the windows and doors at once to create a draught of air which will purge the area;
- shut off the gas cocks;
- get the assistance of a qualified person.

Before lighting the boiler, you are advised to have a professionally qualified person check that the installation of the gas supply:

- is gas-tight;
- is of the correct gauge for the flow to the boiler;
- is fitted with all the safety and control devices required by the current Regulations;
- ensure that the installer has connected the pressure relief valve outlet to a drain pipe. The manufacturers are not responsible for damage caused by opening of the pressure relief valve and consequent escape of water, if not connected correctly to the drain.

Do not touch the appliance with parts of the body that are wet or damp and/or bare feet.

In case of structural work or maintenance near the exhaust duct and/or fume exhaust devices or their attachments, turn off the appliance. On completion of the work, have a professionally qualified person check their efficiency.

3.2 Central heating

For reasonably economical service install a room thermostat.

Never shut off the radiator in the area where the room thermostat is installed.

If a radiator (or a convactor) does not heat up, check that no air is present in it and that its tap is open.

If the ambient temperature is too high, do not alter the radiator taps. Reduce the central heating temperature instead by means of the room thermostat and the special knob (9 in fig. 3.1).

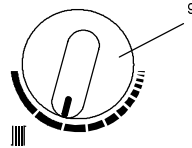

fig. 3.1

3.3 Built in time switch*

The boiler is equipped with a built in time switch (16 on page 1) which controls the central heating operation.

To operate correctly the time switch and for its programming read the separate instructions sheet enclosed with the technical documentation.

3.4 Fume control device

Boilers 24A, 28A, 24AR are fitted with a control device for proper venting of combustion products.

In case burnt gases escape into the room (because the exhaust fume duct is obstructed or working inefficiently) this device cuts off gas supply to the boiler, stopping its operation.

The cut-out appears as a safety stop.

To re-start the boiler, see section 3.8 of this chapter.

Frequent action of the device indicates imperfect operation of the exhaust system (chimney or flue). In these cases it is advisable to contact an Authorised Service Centre.

3.5 Frost protection.

In cold periods, when there is a danger of the appliance freezing up if you do not use it, have a qualified engineer empty the boiler (central heating and domestic hot water circuits) and the central heating and domestic hot water systems.

3.6 Periodic maintenance

For efficient and continuous operation of the boiler, it is advisable to arrange maintenance and cleaning by an Authorised Service Centre Engineer, at least once a year.

* Combi boilers only

2 INSTRUCTIONS FOR USE

2.1 Warnings

In order to guarantee safety and correct operation, it is essential that all the tests are carried out by a competent and responsible service engineer before lighting up the boiler.

The tests are described in the manual *installation instructions* in chapter *preparation for service*.

Ensure that the heating circuit is regularly filled with water (even if the boiler is only used for domestic hot water supply) checking that the pressure indicated on the temperature and pressure gauge (14) is not lower than that shown in fig. 2.2.

If the pressure reading on the pressure gauge is below that shown in fig. 2.2, than the system will require topping up. A filling loop is normally provided by the installer for this purpose.

If you are in any doubt regarding this procedure you are advised to contact your installer or an Approved Engineer.

When the boiler is not lit or used in cold weather, with consequent risk of freezing, empty the boiler (heating and domestic hot water circuits) and the heating and domestic hot water systems.

2.2 Refilling procedure

- 1 Isolate the boiler from the electrical supply at the fused spur. Reconnect the filling loop as demonstrated in fig. 2.1.
- 2 Open the valves of the filling loop and watch the gauge until it reaches normal filling pressure as shown in fig. 2.2.
- 3 Close the valves and remove the filling loop.

If you experience any difficulty in operation of the boiler, switch off the boiler immediately at the fused spur isolation switch and contact your installer or an approved Service Engineer

Air introduced into the boiler during this filling process will vent through the automatic air purger fitted to the boiler. You may also find it necessary to vent air from your radiator circuit using your radiator key, however be aware that excessive venting will cause the pressure in the system to drop.

Always ensure that the pressure gauge is set at the required pressure.

When the pressure has been set, turn on the electricity supply to the boiler and use as normal.

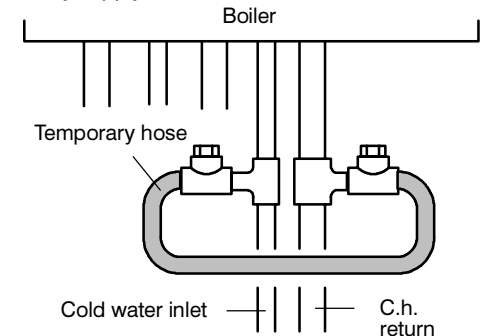

fig. 2.1

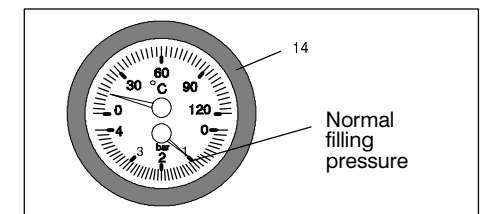

fig. 2.2

2.3 Ignition

- 1 Check that the taps located in the lower part of the boiler are open (fig. 2.3).

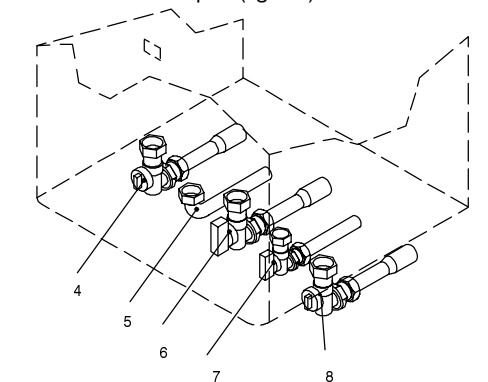

fig. 2.3

- 2 Turn on the electricity supply to the boiler, switching on the fused spur isolation switch.

Instructions for use

- 3 If the boiler is to be used for heating/ domestic hot water (combination boilers) or central heating only (central heating only boiler), position the function switch (11) as in fig. 2.4A (combination boilers) or as in fig. 2.4B (central heating only boiler).

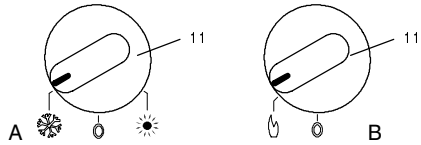

fig. 2.4

- 4 If domestic hot water supply only is required, position the function switch (11) as in fig. 2.5 (Combination boilers).

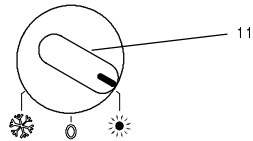

fig. 2.5

2.4 Central heating circuit temperature

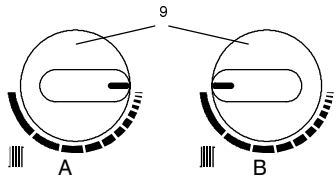

fig. 2.6

The output temperature of central heating water is adjustable from a minimum of about 35°C (fig. 2.6A) to a maximum of about 90°C (fig. 2.6B), by turning the knob (9).

Adjustment of central heating output of the boiler is automatic. The greatest output pre-set in the factory can, however, be reduced in level according to actual system requirements; this does not affect the maximum output in domestic hot water operation.

Such adjustments must be carried out by a qualified person; therefore we advise you to contact an Authorised Service Centre.

Adjustment of the boiler temperature alters the gas flow at the burner according to the thermal demand in the system. So it is usual to see the burner

lit at the minimum level for more or less long periods.

Adjustment

In order to achieve optimal settings for economy and comfort, we recommend adjusting the operating temperature of the central heating water according to the outside temperature, positioning the knob as follows:

Lower than -5 °C from 5 to 15 °C

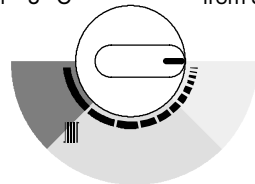

tab. 2.1

Your qualified installer will be able to recommend the most suitable adjustment for your system.

The temperature and pressure gauge (14 on page 1) will allow you to check that the set temperature is obtained.

2.5 Domestic hot water temperature (Combination boiler only)

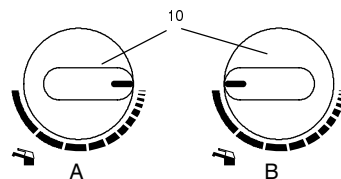

fig. 2.7

The temperature of the domestic hot water leaving the boiler can be varied from a minimum of about 37°C (fig. 2.7A), to a maximum of about 55°C (fig. 2.7B), by turning the knob (10).

Adjustment of the domestic hot water temperature is completely separate from that of the central heating circuit.

The adjustment system integrated with the boiler automatically controls the flow of gas to the burner in order to keep the temperature of domestic hot water delivered constant, between the limits of greatest boiler output.

Instructions for use

Where the demand is at a low level or with the temperature set to the minimum, it is normal to see a cycle of lighting and extinguishing of the burner when running.

Adjustment

It is advisable to adjust the domestic hot water temperature to a level commensurate with the demand, minimising the need to mix with cold water. In this way, the automatic control facilities will be fully exploited.

Moreover, where the amount of limescale present in the water may be particularly great, not exceeding the position in fig. 2.8 of the domestic hot water control knob (10) corresponding to about 50°C (fig. 2.8), minimises annoying incidences of scale deposits and clogging.

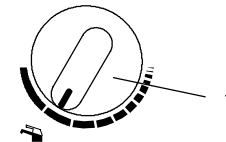

fig. 2.8

In these cases, however, it is advisable to install a small water softener. With such a device you should avoid periodic descaling.

Consequently, the domestic hot water heat exchanger will keep its performance consistent for a long time with resulting gas savings.

If the demand for domestic hot water is so great as to prevent reaching a high enough temperature, have the appropriate output limiting valve installed by an Authorised Service Engineer.

2.6 Extinguishing

To turn the boiler off set the function knob (11) to the position shown in fig. 2.9A (combination boilers) or fig. 2.9B (central heating only boiler).

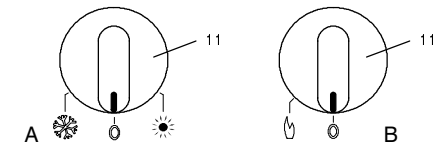

fig. 2.9

When you expect not to use the boiler for a long period:

- 1 Switch off the electricity supply to the boiler, by means of the fused spur isolation switch;
- 2 Shut off the gas supply cock (6) and the cocks for the water circuits (4, 7 and 8) fitted under the boiler (fig. 2.10);

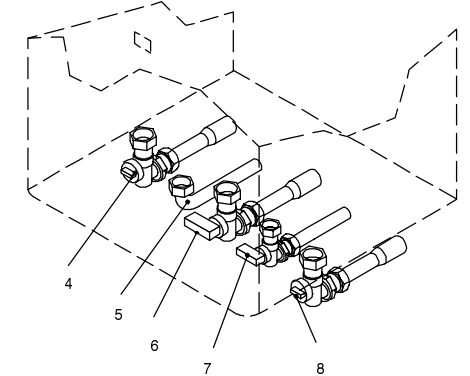

fig. 2.10

- 3 Empty the water circuits, if necessary, as shown in the manual, *installation instructions* in chapter *maintenance*.